

# Single Axis Robot Options / Maintenance Products



## Options

### Handset Terminal



Part Number	
Emergency Stop Button	Normally Closed Input (with Lock)
Deadman's Switch	None Included 3 Position Enable Switch
Operating Temp.	0°C~40°C
Operating Humidity	35% ~ 85%RH (No Condensation)
Body Mass	Approx. 450g
Cable Length	3.5m
Applicable Controller	EXRS-C1/C21/C22

Part Number	Unit Price	Volume Discount Rate
	1 pc.	2 ~ 3 pcs. 4 ~ 5 pcs.

### I/O Cable

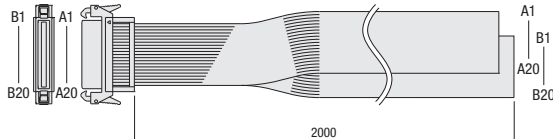

Part Number	
Cable Length	2m
Applicable Controller	EXRS-C1/C21/C22 EXRS-P1

Part Number	Unit Price	Volume Discount Rate
	1 pc.	2 ~ 3 pcs. 4 ~ 5 pcs.

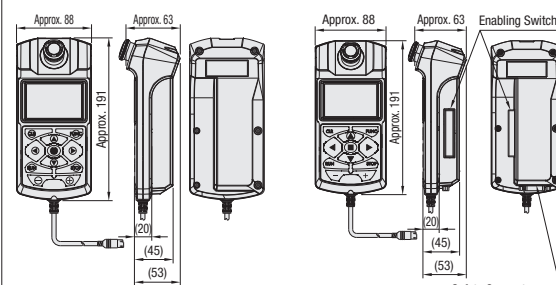

Pin No.	Single	Cable Color	Pin No.	Single	Cable Color	Pin No.	Single	Cable Color	Pin No.	Single	Cable Color
A1	+COM	BR	A11	PIN6	BR	B1	POUT0	BR	B11	OUT2	BR
A2	+COM	R	A12	PIN7	R	B2	POUT1	R	B12	OUT3	R
A3	(NC)	OR	A13	JOG+	OR	B3	POUT2	OR	B13	BUSY	OR
A4	(NC)	Y	A14	JOG-	Y	B4	POUT3	Y	B14	END	Y
A5	PIN0	G	A15	MANUAL	G	B5	POUT4	G	B15	/ALM	G
A6	PIN1	BL	A16	ORG	BL	B6	POUT5	BL	B16	SRV-S	BL
A7	PIN2	V	A17	/LOCK	V	B7	POUT6	V	B17	(NC)	V
A8	PIN3	GY	A18	START/TEACH	GY	B8	POUT7	GY	B18	(NC)	GY
A9	PIN4	W	A19	RESET	W	B9	OUT0	W	B19	-COM	W
A10	PIN5	BL	A20	SERVO	BL	B10	OUT1	BL	B20	-COM	BL

\* Connection end to external device is unterminated.

### Support Software (with USB Communication Cable and D-Sub Communication Cable)

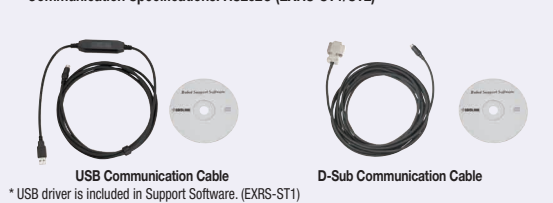

Part Number	Communication Cable Length	Applicable Controller	Unit Price	Volume Discount Rate
	5m	EXRS-C1/P1/C21/C22	1 pc.	2 ~ 3 pcs. 4 ~ 5 pcs.

\* The cables are for communications between controller and PC. \* Not compatible with Windows 7 (OS).

### Lubrication Nozzle

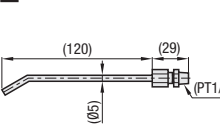

Part Number	EXRS-NZ1
Applications	For replenishing ball screw grease
Applicable Models	RSD1/RSDG1 (Motor mounted on top: U)

Part Number	Unit Price	Volume Discount Rate
EXRS-NZ1	1 pc.	2 ~ 3 pcs. 4 ~ 5 pcs.

\* Recommended Product. This can be used with commercially available grease guns.

### Daisy-chain Cable



Part Number	
Cable Length	300mm
Applicable Controller	EXRS-C1/P1/C21/C22

\* A cable to connect multiple controllers. It can connect maximum 16 controllers.

### Dedicated Feet and Flanges for Rod Type

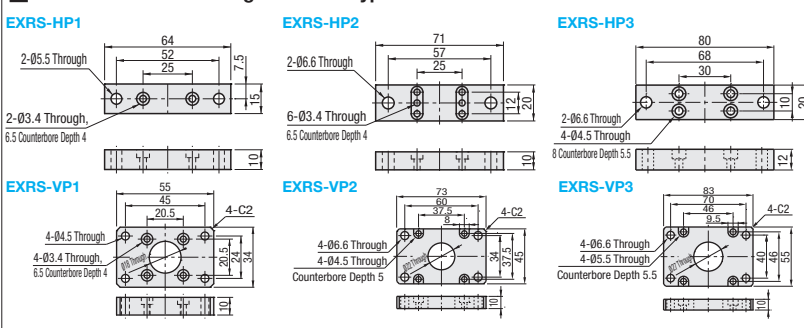

Part Number	Applicable Model	Specifications	Components (1 set)
EXRS-HP1	RSD1/RSDG1	Foot	Mounting Plate 2 pcs.
EXRS-VP1	RSD1	Flange	Mounting Plate 1 pc.
EXRS-HP2	RSD2/RSDG2	Foot	Mounting Plate 2 pcs. Square Nut 12 pcs.
EXRS-VP2	RSD2	Flange	Mounting Plate 1 pc.
EXRS-HP3	RSD3/RSDG3	Foot	Mounting Plate 2 pcs. Square Nut 8 pcs.
EXRS-VP3	RSD3	Flange	Mounting Plate 1 pc.

Part Number	Unit Price	Volume Discount Rate
EXRS-HP1	1 set	2 sets 3 sets
EXRS-VP1		
EXRS-HP2		
EXRS-VP2		
EXRS-HP3		
EXRS-VP3		

### Instruction Manual



Part Number	Language	Type	Applicable Model	Unit Price			Volume Discount Rate		
				1 volume	2 - 3 Copies	4 - 5 Copies	1 volume	2 - 3 Copies	4 - 5 Copies
	Japanese	Actuator (Standard)	RS1/2/3 RSD1/2/3 RSH1/2/3/4/5 RSF4						
		Actuator (Clean Spec.)	RS1C/2C/3C RSH1C/2C/3C						
		Controller	EXRS-C1/C21/C22 EXRS-P1						
	English	Actuator (Standard)	RS1/2/3 RSD1/2/3 RSH1/2/3/4/5 RSF4						
		Actuator (Clean Spec.)	RS1C/2C/3C RSH1C/2C/3C						
		Controller	EXRS-C1/C21/C22 EXRS-P1						

Operator's Manuals are also available for downloads on our website.

## Maintenance Products

### Power/Signal-Integrated Cables (Flex-Resistant)

(Controller EXRS-C1/P1)



Part Number	Cable Length (m)	Unit Price	Volume Discount Rate
	1		
	3		
	5		
	10		

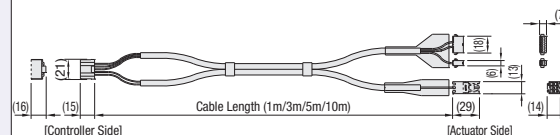

### Data Storage Battery

Part Number	Unit Price	Volume Discount Rate
	1 pc.	2 ~ 3 pcs. 4 ~ 5 pcs.



\* Battery for absolute data back-up. (Applicable Controllers: EXRS-C21/C22)  
\* Included as standard to absolute model controllers. Replacement cycle is approx. one year.  
\* This product is outside the scope of RoHS Directive.  
\* Photograph is an image. Please note that the appearance may differ from the photograph.

### Power/Signal Cables

(Controller EXRS-C21/C22)



Part Number	Type	Cable Length	Unit Price			Volume Discount Rate		
			1 pc.	2 ~ 3 pcs.	4 ~ 5 pcs.	1 pc.	2 ~ 3 pcs.	4 ~ 5 pcs.
	Power	3.5m:	3					
		5m:	5					
		10m:	10					
	(Standard)	Single	3.5m:	3				
			5m:	5				
			10m:	10				
(Flexible)		3.5m:	3					
		5m:	5					
		10m:	10					

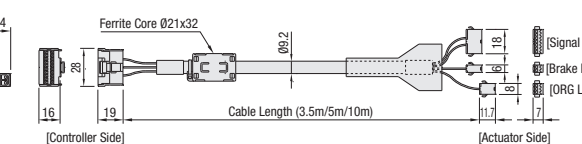
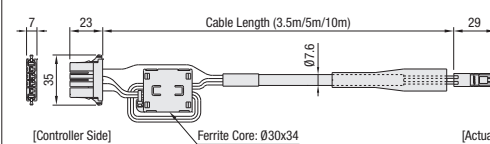

### Noise Filter

Part Number	Rated Voltage	Rated Current	Unit Price	Volume Discount Rate
	AC250V/DC250V	10A	4,300	3,900 3,600

As this product uses push-down type terminal block, it is shipped in the state below.

- \* Terminal cover is stored.
- \* Terminal block screws are kept on the upper side.

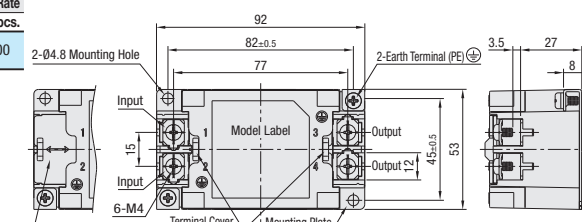

\* Tolerance: ±1  
\* Mass: 300g or Less  
\* Mounting Plate Material: Steel (Surface Treatment: Nickel Plating) t=1.0  
\* Case Material: PBT  
\* Terminal Tightening Torque M4: 1.6N·m (16.9kgf·cm) max

\* These listed products are made by COSEL Co., Ltd.  
\* Other Recommended Products: SOSHIN ELECTRIC-made Part Number: NF2010A-UP



For orders larger than indicated quantity, please request a quotation.

Options can be purchased more economically as Alterations than as single items when purchasing the main products.



For orders larger than indicated quantity, please request a quotation.

Options can be purchased more economically as Alterations than as single items when purchasing the main products.