

Change Valves / One-Touch Articulated Connectors / Resin Connectors

Connectors Guide / Air Couplers

Tube Connection

Change Valves

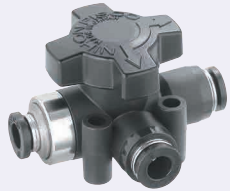

RoHS 10

BVHBV

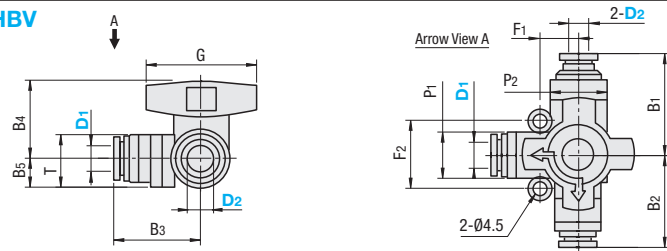

Material Resin Body: Glass Fiber Filled PBT Ball, Guide Ring: Brass (Electroless Nickel Plating) O-Ring: Nitrile Rubber

Part Number	Tube O.D. (mm)		B1	B2	B3	B4	B5	T	F1	F2	P1	P2	G	Effective Sectional Area (mm ²)	Mass (g)	Unit Price	Volume Discount Rate
	Type	Tube O.D. (mm) D1															
BVHBV	6	6	26.9	28.8	27	23.8	8.9	16.2	12	20	14.5	17.8	34.5	9	50		
	8	6	26.9	28.8	26.9	23.8	8.9	16.2	12	20	14.5	17.8	34.5	11	53		
	10	8	28.5	28.7	26.9	23.8	8.9	16.2	12	20	14.5	17.8	34.5	17	50		
	12	10	36.1	36.5	34.8	28	11.9	22.4	15	25	21	23.8	44	24	122		
		12	36.1	36.5	35	28	11.9	22.4	15	25	21	23.8	44	24.5	125		
		12	36.6	36.7										34.5	117		

Features

- Changes the direction of air passage by 90°.
- Resin body is compact and lightweight.
- Easy to handle for changing air passage.

Specifications

Applicable Fluid	Air
Operating Pressure Range	0~0.7MPa
Operating Vacuum Level	-100kPa
Operating Temperature Range	0 ~ 60°C (No Freezing)

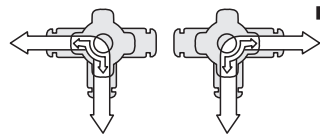

Structure Diagram

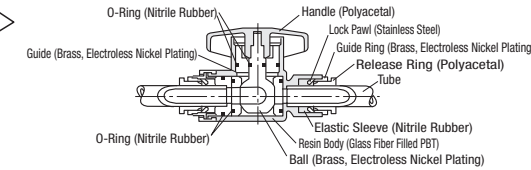

One-Touch Articulated Connectors - Male & Female Set



Material Polyacetal
Accessory: T, H-Type Connector Band (2 pcs. each)

RoHS 10

QCSW

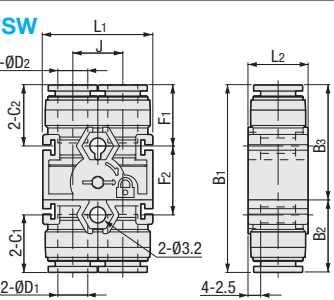

How to Use

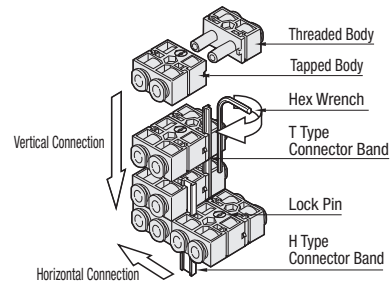

Part Number	Type	D1	D2	B1	B2	B3	L1	L2	C1	C2	F1	F2	J	Effective Sectional Area (mm ²)	Mass (g)	Unit Price	Volume Discount Rate
QCSW	4	4	36.7	14.1	22.6	22	12	11	11	11.8	13.8	10		4.2	11		
	6	6	37.5	14.5	23	22	12	11.6	11.6	12.2	13.8	10		10.4	11		
	8	8	53.9	20.7	33.2	29	17	18.1	18.1	17.2	19.5	14		10.9	31		

Resin Connectors - Sockets



RoHS 10

JCPS

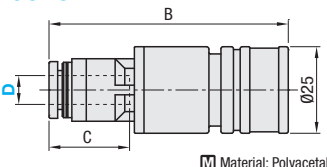

Material: Polyacetal

Part Number	Type	D	B	C	Effective Sectional Area (mm ²)	Mass (g)	Unit Price	Volume Discount Rate
JCPS	6	6	54.8	17	11.5	23		
	8	8	54.7	18.1	19.8	24		
	10	10	59.8	20.2	22.6	28		

When JCPS and JCPP is combined, fluid only flows in sole direction from socket to plug.

Resin Connectors - Plugs



RoHS 10

JCPP

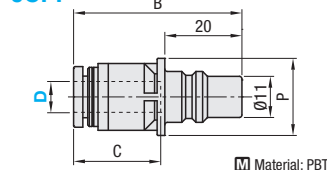

Material: PBT

Part Number	Type	D	B	P	C	Effective Sectional Area (mm ²)	Mass (g)	Unit Price	Volume Discount Rate
JCPP	6	6	38.8	16	17	12.5	7		
	8	8	38.7	16	18.1	23.3	7		
	10	10	45.2	20	20.2	33.8	13		



Part Number JCPP6

Specifications

Applicable Fluid	Air
Operating Temperature Range	0 ~ 60°C (No Freezing)
Max. Operating Pressure	0.9MPa
Operating Vacuum Level	-100kPa



Built-in stop mechanism.

- When JCPS and JCPP is combined, fluid only flows in sole direction from socket to plug.
- Not usable in combination with connectors described P1414 and further.

In order to combine connectors described between P1414 and P1422 for use, refer to the table below. Combination other than described on the table below is not available. Thus, when using connectors, be sure to check the table below.

Pages	Applicable Fluids	Type	Applicable Combined Part Numbers		Applicable to Combining Different Sizes or not.	Remarks
			Plugs	Sockets		
P1414	Air (Water is also applicable partially.)	Tube Connecting	MCPC MCPCS MCPL MCPCLS	MCSC MCSCS MCSCSCL MCSCBS	○	Only Size 4 and 6 is applicable to MCPS / MCPCS / MCSC / MCSCS.
P1415 1416 1418		Standard Type (Including Rotary / Locking / Branch Type)	MCPM MCPMS MCPF MCPF MCPH MCPHS MCPN MCPN MCPS MCPRM MCPRF (MCRN MCRT MCLTR MCRE)	MCSM MCSMS MCHSM MCSF MCSFS MCHSF MCHS MCHS MCHSH MCSN MCSC MCSCS MCSTM MCSTFN MCSTH (MCRN MCRT MCLTR MCRE)	○	Only Size 8 and 10 is applicable to MCPS / MCPCS / MCSC / MCSCS. Branch Type has both the Plug and Socket shapes.
P1417		Lightweight	KSCPM MSCPF KSCPH KSCPN	KSCSM KSCSF KSCSH KSCSN	○	-
P1419		Miniature	NMCPM NMCPMS NMCPF NMCPFS NMCPH NMCPHS NMCPHL NMCPHLS	NMCSM NMCSMS NMCSHB NMCSHBS NMCSH NMCSHS NMCSHL NMCSHLS	○	-
P1420		Chemical Resistant Type - EN 1.4401 Equiv.	MCPMSS MCPFSS MCPHSS	MCSMSS MCHSSS	×	-
P1421	Water, Oil, Air	No Valve Type	QNPFC QNPFS QNPMC QNPMS QNPFC QNPFS	QNSFC QNSFS QNSMC QNSMS QNSHC QNSHS	×	When Threaded / Tapped Type and Hose Connecting Type are used in combination with each other, check their sizes. P1421
P1422		Valve Type	QBPFC QBPFS	QBSFC QBSFS	×	-
P1422		High flow rate Valve Type	QBPFCH QBPFH	QBSFCH QBSFH	×	-
P1422		210 High Pressure Valve Type	QBPH	QBSHT	×	-
P1422	350 High Pressure Valve Type	QBPHTP	QBSHTP	×	-	

Tube Connecting Plugs

Straight

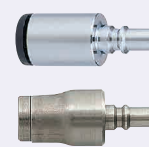

Type	Material	Surface Treatment
MCPC	Brass	Chrome Plating
MCPCS	EN 1.4401 Equiv.	-

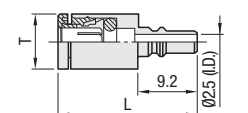

Part Number	Type	No.	L	T	Mass (g)	MCPC		MCPCS	
						Unit Price	Volume Discount Rate	Unit Price	Volume Discount Rate
MCPC	4	24.5	8.1	3 (5.5)	1 ~ 9 pc(s).	10~30	1 ~ 9 pc(s).	10~30	
MCPCS	6	28.0	10.1	5 (9)					

Values in () are for MCPCS.

Select the same number as that of the tube O.D.

Tube Connecting Sockets

Straight



Type	Material	Surface Treatment
MCSC	Brass	Chrome Plating
MCSCS	EN 1.4301 Equiv.	-

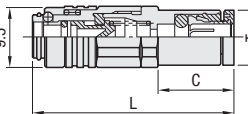

Part Number	Type	No.	L	C	T	Mass (g)	MCSC		MCSCS	
							Unit Price	Volume Discount Rate	Unit Price	Volume Discount Rate
MCSC	4	31.5 (34.6)	11.8 (11)	8.1	9 (11.4)	1 ~ 9 pc(s).	10~30	1 ~ 9 pc(s).	10~30	
MCSCS	6	33.5 (37)	12.5 (13)	10.1	11.5 (16.2)					

Values in () are for MCSCS.

Select the same number as that of the tube O.D.

For Vessels

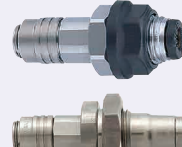

Type	Material	Surface Treatment
MCSCB	Brass	Chrome Plating
MCSCBS	EN 1.4301 Equiv.	-

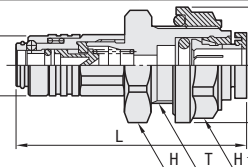

Part Number	Type	No.	L	D	T	Wrench Flats H	Wrench Flats H1	Mass (g)	MCSCB		MCSCBS	
									Unit Price	Volume Discount Rate	Unit Price	Volume Discount Rate
MCSCB	4	34 (42.1)	16 (19.6)	M10x1(M12x1)	13 (15)	13 (17)	15 (26.2)	1 ~ 9 pc(s).	10~30	1 ~ 9 pc(s).	10~30	
MCSCBS	6	36 (45)	18 (25.4)	M12x1(M16x1.5)	15 (18)	15 (22)	18.5 (45.4)					

Values in () are for MCSCBS.

Elbows



Type	Material	Surface Treatment
MCPC	Brass	Chrome Plating
MCPCLS	EN 1.4401 Equiv.	-

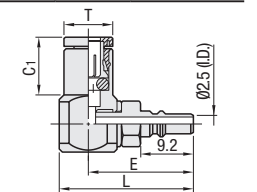

Part Number	Type	No.	L	T	E	C1	Mass (g)	MCPC		MCPCLS	
								Unit Price	Volume Discount Rate	Unit Price	Volume Discount Rate
MCPC	4	23.8 (23.3)	8.1	18.3	10 (11)	10 (10.9)	1 ~ 9 pc(s).	10~30	1 ~ 9 pc(s).	10~30	
MCPCLS	6	24.3 (26.3)	10.1	18.8 (19.8)	12 (13)	13.5 (19.7)					

Values in () are for MCPCLS.

Elbows

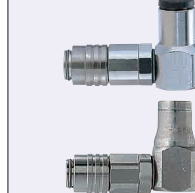

Type	Material	Surface Treatment
MCSC	Brass	Chrome Plating
MCSCS	EN 1.4301 Equiv.	-

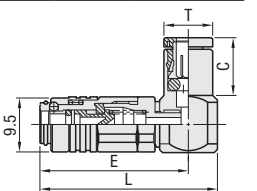

Part Number	Type	No.	L	C	T	E	Mass (g)	MCSC		MCSCS	
								Unit Price	Volume Discount Rate	Unit Price	Volume Discount Rate
MCSC	4	30.8	10 (11)	8.5 (8.1)	25.8	16 (15.5)	1 ~ 9 pc(s).	10~30	1 ~ 9 pc(s).	10~30	
MCSCS	6	31.8 (33.8)	12.5 (13)	10.3 (10.1)	26.3 (27.3)	19 (24.3)					

Values in () are for MCSCS.

Specifications

Seal Material	Operating Temperature	Max. Operating Pressure MPa (kgf/cm ²)	Applicable Fluid
Nitrile Rubber (NBR)	-20~60°C (No Freezing)	Brass: 1.0 (10) EN 1.4301 Equiv.: 1.0(10)	Air

- Single Passage Opening Closing System (Valve is provided on the socket side.)
- For combination with a tube, select the same number as that of the tube O.D.
- The specifications described here are those for coupler main bodies. The actual pressure specification, operating temperature range and etc. vary depending on the material of the tubes.



Part Number MCP4
MCPC4
MCSC6